



**sun
age**

Sun-age srl
Via Panica 121
36063 Marostica (VI)
www.sun-age.it

Scheda tecnica KIT

Denominazione	STAFFA MAGICA		
Codice prodotto	K 610 D 22		
Descrizione prodotto	Piastra grande alluminio 1 morsetto terminale viteria e cursori inclusa inox staffa alta regolabile		
data	02-09-2013	scala disegno	1:2

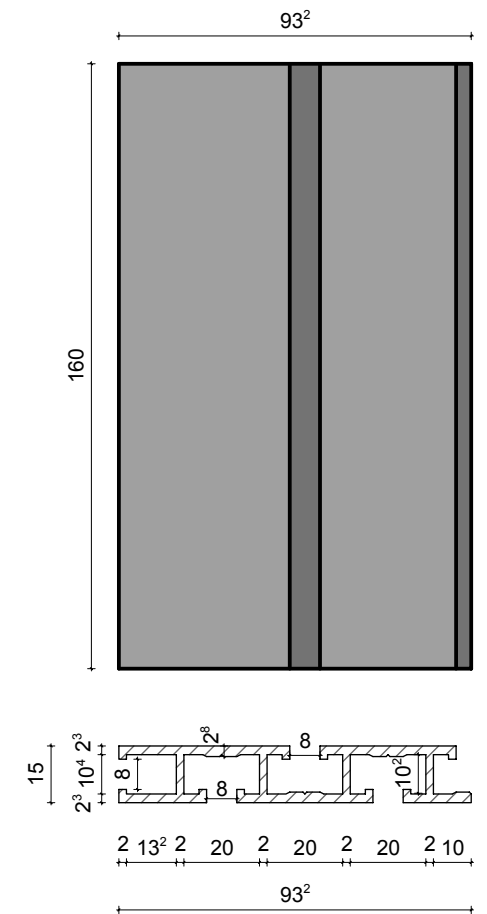
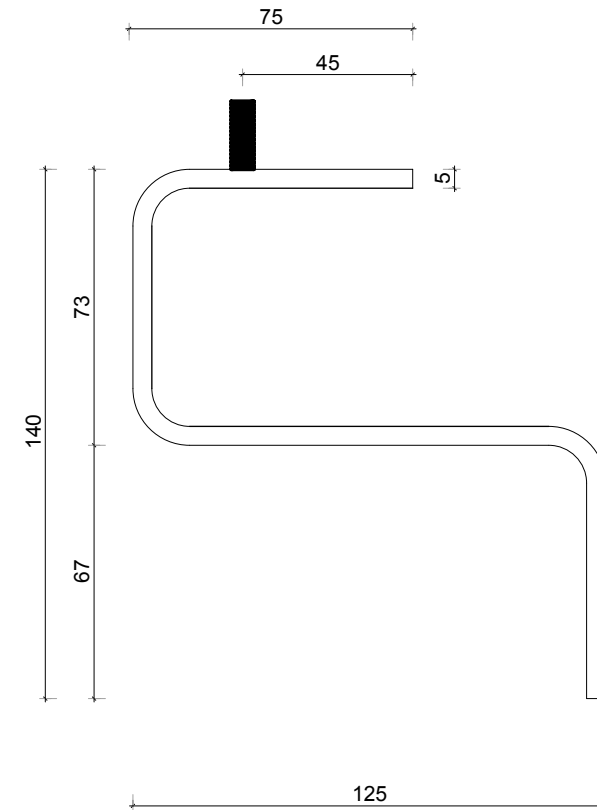
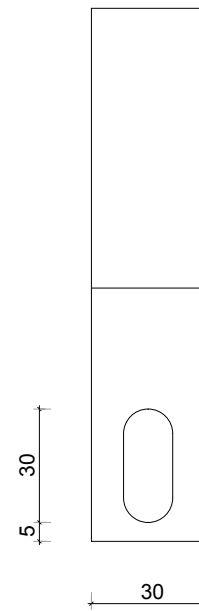
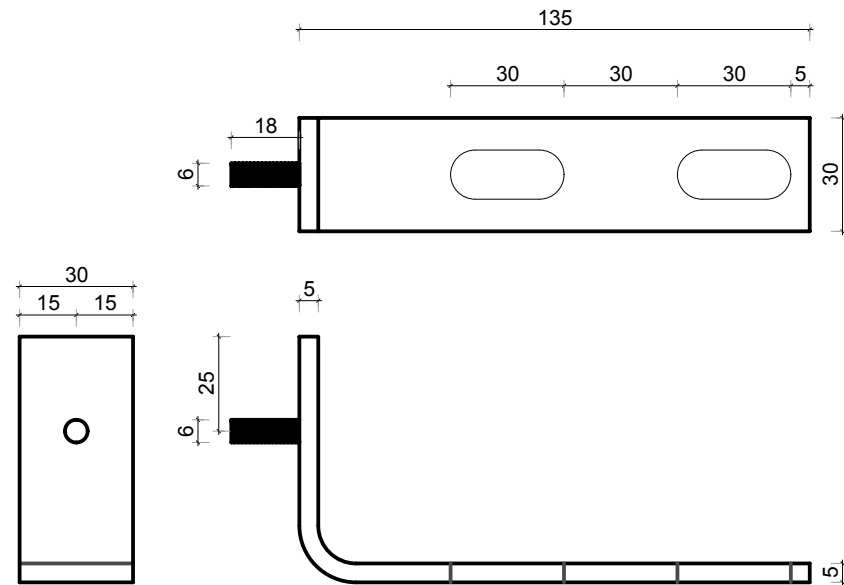
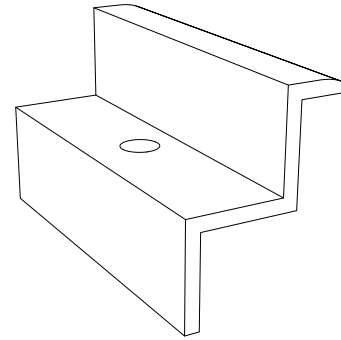
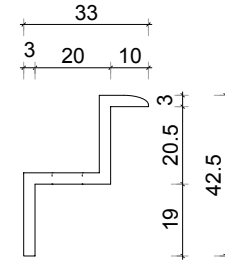
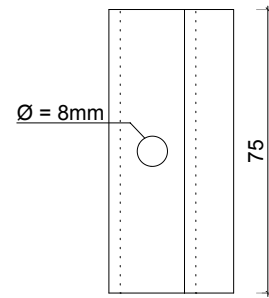

Codice	Articolo	Descrizione	Quantità	Note	Codice Fornitore:
Materiale			Peso	Lavorazioni	
Controllato:				Kit	